

5/8" SIMULATED DIVIDED LITE WITH INTERNAL GRILLE

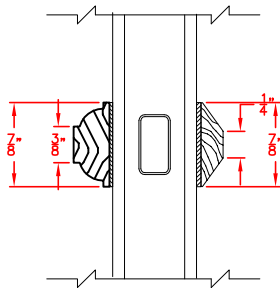

7/8" SIMULATED DIVIDED LITE WITH INTERNAL GRILLE

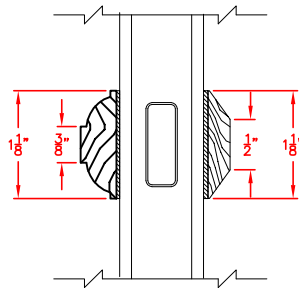

1-1/8" SIMULATED DIVIDED LITE WITH INTERNAL GRILLE

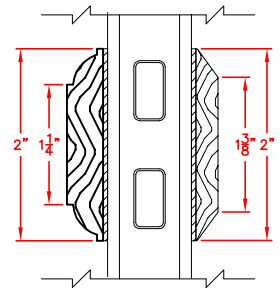

2" SIMULATED DIVIDED LITE WITH INTERNAL GRILLE

WOOD SIMULATED DIVIDED LITE

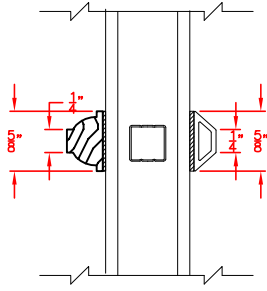

5/8" SIMULATED DIVIDED LITE WITH INTERNAL GRILLE

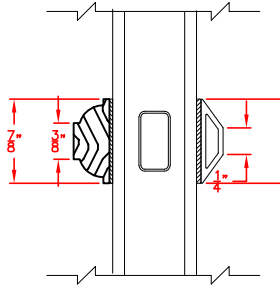

7/8" SIMULATED DIVIDED LITE WITH INTERNAL GRILLE

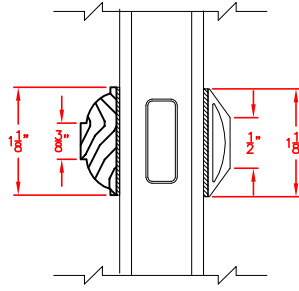

1-1/8" SIMULATED DIVIDED LITE WITH INTERNAL GRILLE

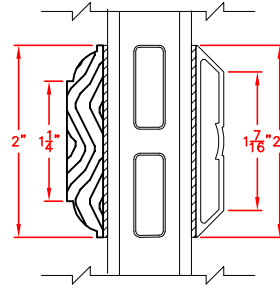

2" SIMULATED DIVIDED LITE WITH INTERNAL GRILLE

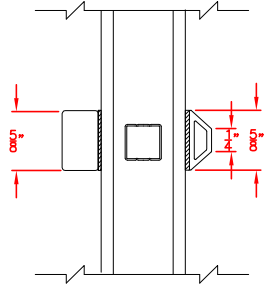

5/8" SQUARE SIMULATED DIVIDED LITE

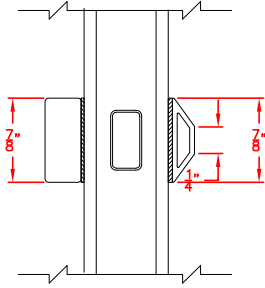

7/8" SQUARE SIMULATED DIVIDED LITE

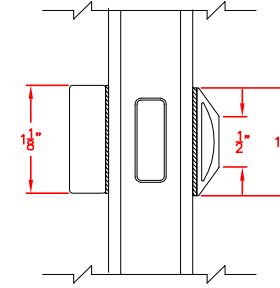

1-1/8" SQUARE SIMULATED DIVIDED LITE

CLAD/WOOD SIMULATED DIVIDE LITE CASEMENTS/AWNINGS/PATIO DOORS QUANTUM DOUBLE HUNG

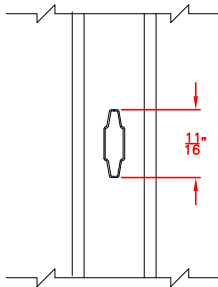

INTERNAL GRID

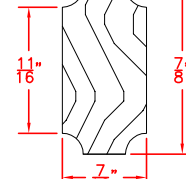
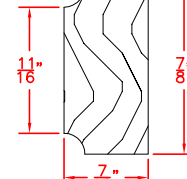
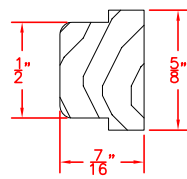
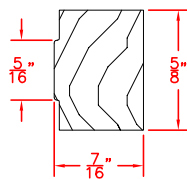

INTERIOR GRID SCALE 2X



GRID OPTIONS - STANDARD PRODUCTS
SCALE: 6" = 1' 0"

LINCOLN WOOD PRODUCTS, INC.

1400 W. TAYLOR ST.

Merrill, WI 54452

(715) 536-2461

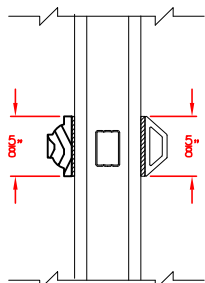

5/8" SIMULATED DIVIDED LITE

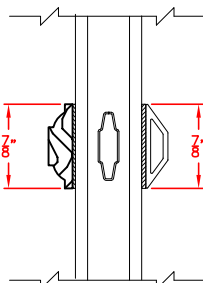

7/8" SIMULATED DIVIDED LITE

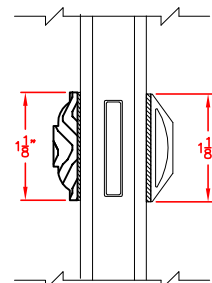

1-1/8" SIMULATED DIVIDED LITE

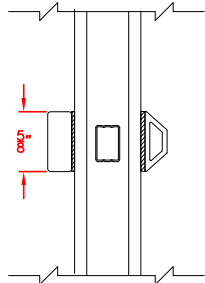

5/8" SQUARE SIMULATED DIVIDED LITE

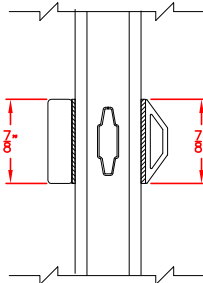

7/8" SQUARE SIMULATED DIVIDED LITE

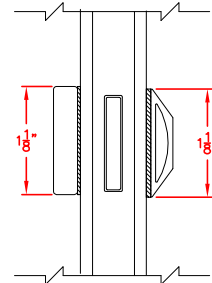

1-1/8" SQUARE SIMULATED DIVIDED LITE

**CLAD/WOOD SIMULATED DIVIDE LITE
DOUBLE HUNG / GLIDER WINDOWS**

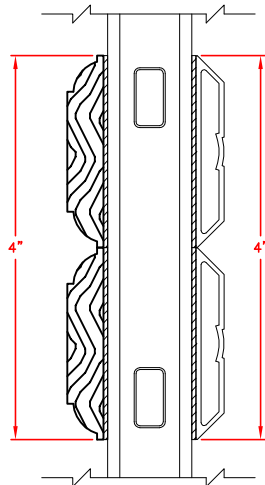

4" SIMULATED DIVIDED LITE
WITH INTERNAL GRID

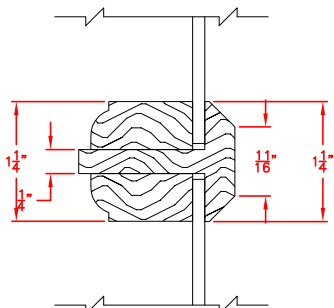
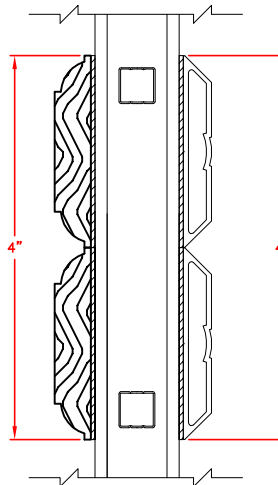

SINGLE GLAZED
TDL 1-1/4"

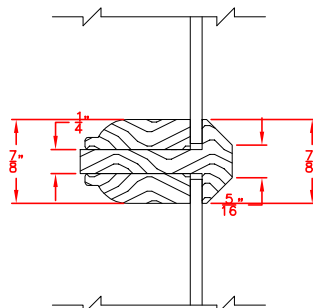

SINGLE GLAZED
TDL 7/8"

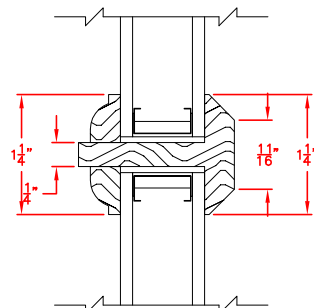

INSULATED GLASS
TDL 1-1/4"

TRUE DIVIDED LITE



GRID OPTIONS - STANDARD PRODUCTS
SCALE: 6" = 1' 0"

LINCOLN WOOD PRODUCTS, INC.

1400 W. TAYLOR ST.

Merrill, WI 54452

(715) 536-2461